

## History

In the 1930s the German army began research into long range rockets. Working at Peenemünde on the Baltic coast, Wernher von Braun and his team developed a series of liquid-fuelled designs, culminating in the A-4. This revolutionary rocket, standing over 46 feet tall, first flew successfully on 3 October, 1942. It was fuelled by methyl alcohol and liquid oxygen, and featured a gyroscopic guidance system. Armed with a 2,000 lb explosive warhead, the A-4 was renamed for propaganda purposes V-2 (V standing for *Vergeltungswaffe*, or vengeance weapon). By the end of the Second World War over 5,000 had been built, most being fired at the cities of London and Antwerp. The high speed of the V-2 made them immune to interception. Although they caused great destruction and loss of life, their guidance system was too inaccurate to hit any target smaller than a city, and their military effect was small in proportion to the resources employed in their manufacture. In spite of these shortcomings, the American and Soviet governments showed great interest in the V-2, and both countries recruited German rocket scientists after the end of the war. The V-2 is a direct ancestor of the Scud missile employed in the Gulf War, and of the giant Saturn V rocket that sent the first humans to the moon.

## The Model

This model builds into an accurate and detailed 1/32 scale replica that stands over 17 inches tall. A word of caution: this is not suitable for assembly by young children, due to the use of sharp tools and the complexity of some assembly steps. It is recommended for those with some previous experience in card modeling. If you have any comments or suggestions regarding this kit, I can be reached by e-mail at [models@currell.net](mailto:models@currell.net)

This document contains the instructions only. Model parts are contained in a separate document. Print out the part sheets on 8.5"x11" or A4 size white card stock suitable to your printer. Sheet **G** contains structural formers, and may if desired be printed on heavier stock. Alternately, extra parts are provided on sheet **G** to allow you to "double up" the formers.

## Tools

Before beginning, you will need the following tools and materials:

- a) white glue
- b) a glue applicator such as wooden toothpicks or a small paintbrush
- c) scissors
- d) a sharp knife for cutting
- e) a flat cutting surface
- f) a ruler or straight edge
- g) a scoring tool or blunt knife for creasing the fold lines.

## Hints

- a) Select a well-lit, comfortable work area that will remain undisturbed when you are not there.
- b) Keep your hands and tools clean when working, to avoid getting glue on visible parts of the model.
- c) It's easier to stay organized if you only cut out those parts you need for each step.
- d) Make sure your knife is sharp. When cutting straight lines, use a straight-edge. Scissors, if used carefully, can be used for large curved parts.
- e) Study the diagrams carefully, and always test-fit the parts before applying glue.
- f) You may wish to colour the edges of the parts to make seams less visible. Pencil crayon or paint applied with a fine brush can be used (experiment on scrap pieces to see what works best).

## Assembly

These instructions apply to both the colour (camouflaged) and black & white versions of the model. Directional terms such as "top" and "bottom" assume the rocket is vertical (fins at bottom). Scoring of parts is usually indicated by thin black lines outside the part's outline. Score parts *before* cutting them out. In the diagrams, subassemblies are identified by a number within a circle (e.g. ②), corresponding to the step number in which it was assembled.

Assemble the body sections (**steps 1–4**). The body of the rocket is made up of seven assemblies. These assemblies comprise an outer surface segment (the "skin" of the rocket), a connecting strip and (except for the nose cone) a circular former to provide strength and maintain the segment's shape. To construct a typical assembly, carefully cut out the parts and glue the connecting strip to the inside of the surface segment. These strips have a thin line along the centre, which must be lined up with the respective edges of the surface segment (see the diagrams). The segment is then rolled so the edges butt together and are held by the connecting strip. Once dry, the former ring is

glued inside the assembly, as close to the narrow end as necessary to obtain a snug fit.

Assemble the exhaust cone (**step 5**). Remember that the gray printed side of the exhaust cone will be on the inside.

Join the nose sections (**step 6**) and the tail sections (**step 7**) ensuring the vertical seams line up. All remaining parts will be attached to the tail, so the nose can be set aside until later.

There are four fins. The fin shape is somewhat complicated, so study the drawings carefully and dry-fit the parts before applying glue. When cutting out the fins, ensure that the centre-line is scored for folding, and that the two narrow slots at the bottom (separating the rudder from the fin body) are cut. Each fin requires an interior supporting structure (**step 8**), which is made up of four struts folded and glued in accordance with the template on parts sheet A. This structure is glued into one side of the fin, and the other side is folded over (**step 9**). The leading and outside edges of the fin, the rudder, and the angled bottom edge are then glued together to form a sharp edge.

Attach the fins to the tail assembly, gluing to the lightly shaded areas on the side of the body (**step 10**). If building the black and white version, the orientation of each fin is determined by its markings. Proper alignment is crucial to the appearance of the final model! Ensure that the fins are exactly 90 degrees apart, and that the base of the fin, where it meets the body, is flush with the body's base plate. Also verify that the bottom of the fins are all at the same level (all four fins should rest on a flat surface with no wobble). Attach the exhaust cone, taking care that it is centred, and that the tabs on the bottom line up with the fins.

Assemble the servo motor housings (**step 11**). When cutting out the end plate E9, it will be easier if the hole is opened before the outside edges are cut. Note that the side plates A2-A9 are numbered; both sides of each housing must have the same number. Assemble the exhaust vanes (**steps 12-14**).

Glue the servo housings from step 11 to the fins, ensuring the numbers correspond to the fin number (**step 15**). Assemble the antennae E10 and the chain drive covers E5 (**step 16**).

Attach the fairing panels A10-A17 such that they form a smooth arc between the fins and the body (**step 17**). The curve at the base of these panels should match the curve of the housings directly beneath them. Thin lines on the side of the fin and the body indicate where the edges of the fairings line up. Attach the antennae to the bottom of the fins, and the chain drive covers (narrow end up) to each side of the fins. Form the connector covers D3-D5 and attach to the body sides. Attach the exhaust vanes to the holes in the drive housings, leaving 0.05" (1.4 mm) of the drive shaft exposed.

Finally, glue the nose section to the tail (**step 18**), ensuring the body seams line up.

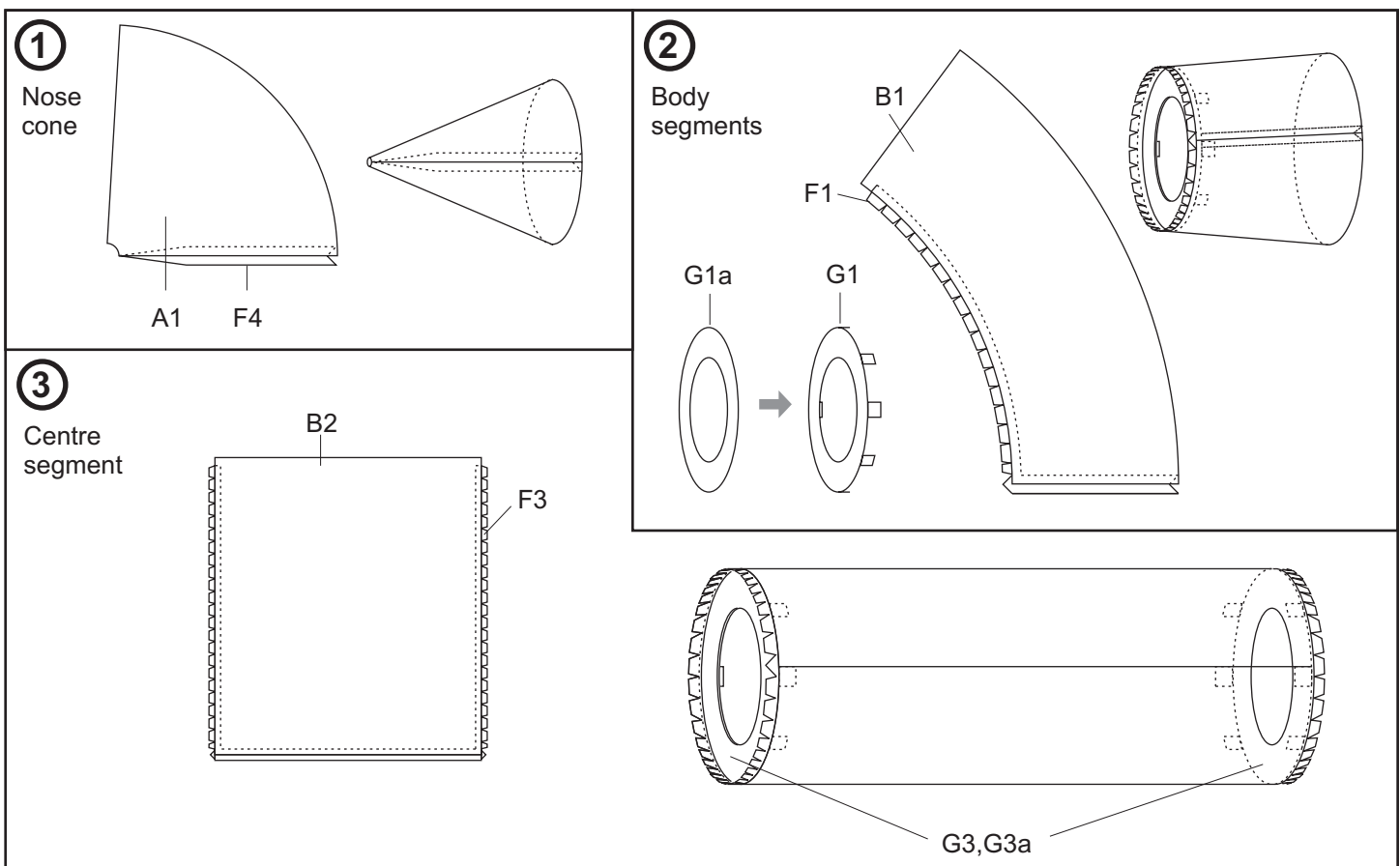



**11** Servo motor housing (4 pieces)

Parts A2-A9 have numbers printed on them. Left and right sides of each assembly must have same number.

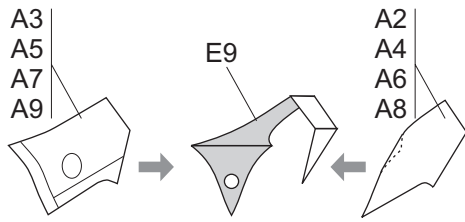

**12** Vane base (4 pieces)

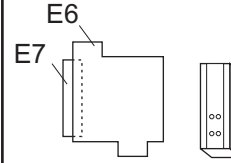

**13** Vane parts (4 of each)

Parts E8, E11 fold over and glue, then cut out shape

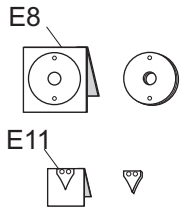

**14** Vane assembly (4 pieces)

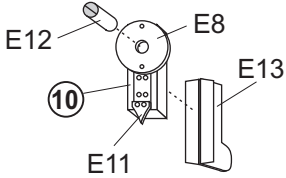

**15** Servo housing placement

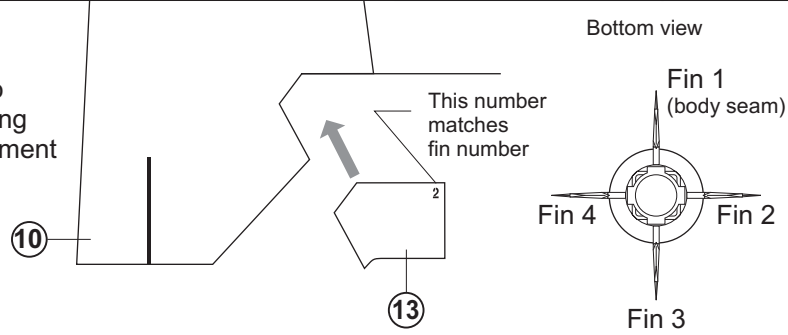

**16** Antennae & chain drive covers

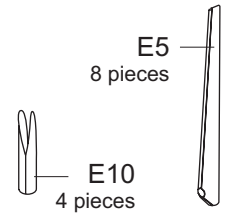

**17** Fairings & miscellaneous parts

Fairings (parts A10-A17) curve to match shape of servo housing assembly

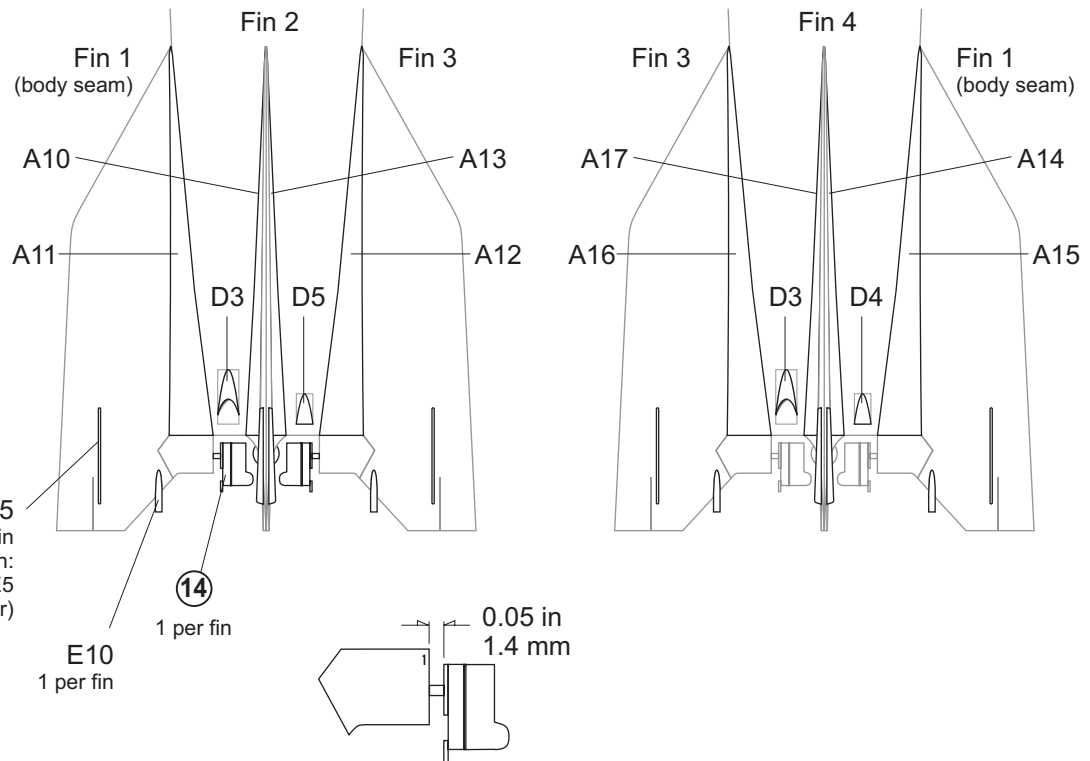
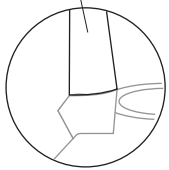

**18** Final assembly

